

TECHNICAL GUIDE FOR LIMIT SWITCHES

TERMINOLOGY

Snap action

Snap action is a mechanism for quickly reversing the switch contacts from one position to another. The contacts at this time move at a speed that is mostly independent of the speed of actuator movement. Since the contacts of snap-action basic switches open quickly, snap-action basic switches have a short arc time between contacts, and as a result demonstrate little contact wear, and allow large currents to be switched.

Slow action

Slow action is a contact mechanism in which switch contact operation is directly affected by external operating speed.

Terms relating to contact switching time

Unstable time (chattering time):

In snap-action operation, the force with which the contacts touch each other decreases as the actuator is pushed in. Immediately before the operating position (O.P.), the contact force is small, resulting in an unstable contact state. The time of this unstable contact state is called chattering time.

Switchover time (transfer time):

This is the time it takes for the moving contact to travel between the N.C. contact and the N.O. contact.

Bounce time

This is the time it takes for the moving contact to stabilize after slightly jumping when it mechanically impacts the N.O. contact.

Switchover time (snap-over time):

This is the time it takes for the contact to reverse from the N.C. contact to the N.O. contact, including the above chattering and bounce times.

Switchover time (snapback time):

This is the time it takes for the contact to reverse from the N.O. contact to the N.C. contact.

Switchover time (snap-over time)

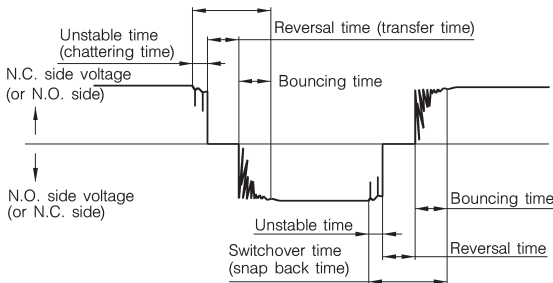

Wiping of contacts (sliding)

Contact wiping is the operation of the moving contact sliding over the fixed contact with a certain degree of contact pressure when an external force is applied to the actuator to snap the moving contact back. The figure below shows wiping action during operation and return of the moving contact. Wiping has the effect of cleaning the surface of the contacts and separating fused contacts caused by inrush current.

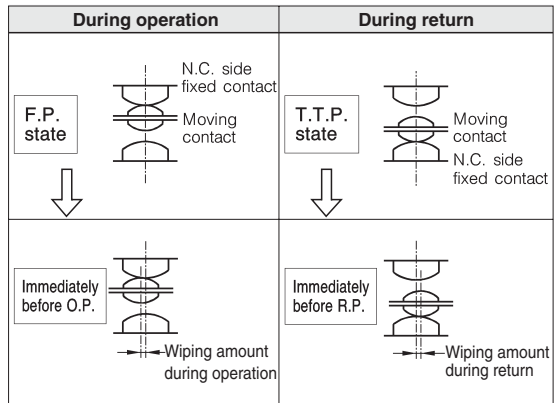

Contact gap

The contact gap of basic switches is the spatial distance from the surface of the moving contact to the surface of the N.O. fixed contact as shown in the figure below. The following table shows the contact gaps as laid down in JIS standards.

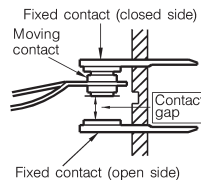

Contact gap	JIS symbol	Yamatake
0.25mm	H	R
0.50mm	G	2R
1.00mm	F	4R
1.80mm	E	7R

Generally, when the contact gap is set to a small value, the movement differential (M.D.) is small and a high-sensitivity switch can be obtained. For this reason, a small contact gap is used for limit switches used in measurement applications such as temperature switches and pressure switches. Alternately, when the contact gap is set to a large value, the contact force is larger, which makes it ideal for use in locations subject to large vibration and impact. However, a large contact gap shortens the mechanical life, since it increases the amount of deflection and travel of the moving spring.

Terminology relating to operating characteristics

Force

- O.F. (operating force)
Amount of force applied to the actuator to cause contact snap-over to the operating position from the free position.
- R.F. (release force)
Amount of force applied to the actuator to cause contact snapback to the return position from the total travel position.
- T.T.F. (total travel force)
Amount of force applied to the actuator to cause contact movement to the total travel position.

Travel

- P.T. (pretravel)
Actuator travel or angle from the free position to the operating position
- O.T. (overtravel)
Actuator travel or angle to the total travel position from the operating position
- M.D. (movement differential)
Actuator travel or angle from the operating position to the return position
- T.T. (total travel)
Actuator travel distance or angle from the free position to the total travel position

Position

- F.P. (free position)
Position of actuator when no external force is applied
- O.P. (operating position)
Position of actuator at which the moving contact snaps from the free position when an external force is applied on the actuator
- R.P. (release position)
Position of the actuator at which the moving contact snaps from the operating position to the free position when external force decreases.
- T.T.P. (total travel position)
Position of actuator at which actuator reaches the actuator stopper

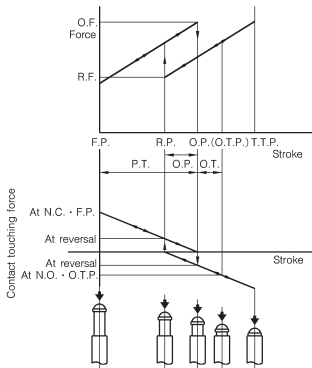
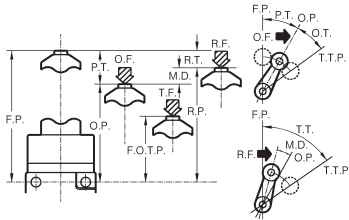

Note: How to Interpret Minimum and Maximum in Operating Characteristics

Maximum: Taking operating force (O.F.) as an example, all switches operate if the force applied to the actuator increases to the maximum O.F. value. Alternately, from a mechanical standpoint, the maximum O.F. is the required amount of force applied to the switch for it to operate.

Minimum: Taking return force (R.F.) as an example, all switches return if the force applied to the actuator decreases to the minimum R.F. value. Alternately, from a mechanical standpoint, the minimum R.F. is the required amount of force applied to the switch for it to return. In other words, the meaning of minimum and maximum used in describing switch characteristics alternately becomes the maximum and minimum mechanical conditions at which the switch is used.

Sealed connector

This part is used to ensure sealability of the switch conduit when cable is connected to the limit switch.

Spatter-guarded limit switches

These limit switches are used in welding processes. The switch housing material, coating and actuator moving parts of these limit switches are specially treated to protect the switch from adhesion of welding spatter

Break-before-make (Break-Before-Make Type)

With this contact system, the N.O. (normally open) contact always turns ON after the N.C. (normally closed) contact turns OFF when contact operation is switched on slow action type limit switches. During the contact operation phase, there is always a state in which both the N.O. and N.C. contacts are OFF (dead break state).

Set position indication function

LS and 14CE Series lever and plunger type models have a setting pointer and setting zone so that the lever can be set for correct operation, without being pushed in too far or not far enough.

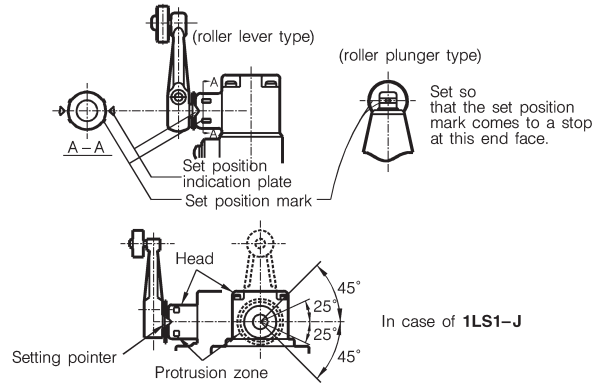

Pilot duty

Pilot duty is a rating for switches and equipment that control high inductive loads with a low power factor. Typical examples of pilot duty are electromagnetic loads such as contactors, solenoids, and valves.

Generally, pilot duty often indicates a power factor of 35% or less and an inrush current of 10 times the steady current or more. Pilot duty is stipulated in UL testing.

Switching current

This level of current will satisfy the specified electrical life and takes into consideration inrush current when contacts turn ON and breaking current when contacts turn OFF.

Operating frequency

There are two types of operating frequency, mechanical and electrical.

- Mechanical operating frequency: When switching operation is performed with overtravel set at the specified amount and in an electrically no-load state, there is a point at which contact switching operation can no longer follow actuator operation if the operating frequency increases externally, due to inertia caused by the weight of the actuator, snap-action mechanism, and contacts. Mechanical operating frequency is the maximum frequency at which contacts can follow actuator operation without any mechanical damage to the switch actuator.
- Electrical operating frequency: This is the maximum operating frequency at which contacts can be switched without any damage caused by transfer, wear and fusing due to contact temperature rise when the load is electrically switched.

Mechanical life

This is the duration of use until mechanical damage or a change of $\pm 20\%$ or more of the initial values of any characteristic occurs after switching is performed with overtravel (O.T.) set according to the specifications and in an electrically no-load state.

- Minimum mechanical life is the value (5% fraction defective) at which 5 of 100 switches are judged to be defective by the above test. This minimum mechanical life is always used as the mechanical life value in Yamatake catalogs.
- Average mechanical life: This is the value (50% fraction defective) at which 50 of 100 switches are judged to be defective by the above test.

Electrical life

This is the duration of use when switching is performed at the specified operating frequency with overtravel (O.T.) set according to the specifications and with the rated load (resistive load) or specified load applied.

Allowable operating speed

This is the travel speed of cams or dogs at which switching can be reliably performed without any mechanical damage to the actuator, for example, or any damage to the contacts. Yamatake stipulates as follows:

- At maximum allowable speed, the actuator does not break.
- At minimum allowable speed, unstable contact lasts for 0.1s or less.

Common contact (COM contact)

This is the contact that is used in common for switching N.C. and N.O. contacts on an SPDT basic switch.

Normally open contact (N.O. contact, "A" contact)

This contact is in an electrically OFF state when no external force is applied to the limit switch's actuator (in free position, F.P.).

Normally closed contact (N.C. contact, "B" contact)

This contact is in an electrically ON state when no external force is applied to the limit switch's actuator (in free position, F.P.).

Rated voltage

There are two rated voltages, rated insulation voltage and rated operating voltage.

Rated insulation voltage is the voltage stipulated according to the creep distance and spatial distance of the contacts and terminals of the limit switch.

Rated operating voltage is the actually usable voltage at which electrical life is satisfied at the rated insulation voltage or less.

RUBBER MATERIAL FOR SEALS

Generally, oil-resistant nitrile rubber (NBR) is used on standard products. Weather-resistant chloroprene rubber (CR) is also available for some models. Cracks will appear in oil-resistant rubber in a short time if it is exposed to direct sunlight. On the other hand, weather-resistant rubber will swell or harden if it is used in locations subject to splashing by oil.

Thus, oil-resistant and weather-resistant rubber have contrasting characteristics. For this reason, use them selectively according to the operating environment in which they are to be used.

- Silicone rubber (Si) is used for cold- and heat-resistant switches.
- Fluoroplastic rubber (FPM) is used for oil-, weather-, heat-, and chemical-resistant switches.

Rubber materials

Rubber materials for seal	Application	Harsh environment specifications	Operating temperature	Cautions for use
Nitrile-butadiene rubber (NBR)	Indoor use	Oil-resistant	-20 to + 80°C	Not weather-resistant
Chloroprene rubber (CR)	Indoor and outdoor use	Weather-resistant	-20 to + 80°C	Not oil-resistant
Silicone rubber (Si)	Indoor and outdoor use	Cold-, heat-, and weather-resistant	-55 to +120°C	Not oil-resistant
Fluoroplastic rubber (FPM)	Indoor and outdoor use	Oil-, weather-, heat-, and chemical-resistant	- 5 to +120°C	Not cold-resistant

CABLE MATERIALS

Generally, three types of materials are used for covering cables, regular PVC, oil-resistant PVC, and chloroprene. Select the needed type of cable by referring to the following table.

Characteristics	Cable material												
	Weather-resistant	Ozone-resistant	Oil-resistant	Waterproof	Cold-resistant	Heat-resistant	Wear-resistant	Long life	Flexibility	Repulsion elasticity	Compression set	Elastic efficiency	Hardness change
Regular PVC	○	○	○	○	○	○	○	○	○	○	○	○	○
Oil-resistant PVC	◎	◎	◎	◎	◎	◎	◎	◎	◎	◎	◎	◎	◎
Chloroprene	◎	◎	◎	◎	◎	◎	◎	◎	◎	◎	◎	◎	◎

◎: Superior ○: Average —: Inferior

CHECKLIST WHEN SELECTING LIMIT SWITCHES

Operating conditions (mechanical conditions)	Force Movement Position Accuracy Return Speed Frequency	Operating force (O.F.), release force (R.F.), Pretravel (P.T.), overtravel (O.T.), movement differential (M.D.), Operating position (O.P.), free position (F.P.), release position (R.P.), Repeat deviation, repeat accuracy, Self return, forced return, Impact, high/low/very low speed, Operations/minute
Load conditions (electrical conditions)	Power Load current Other load details Circuit configuration Electrical life	AC/DC, frequency, voltage, Usual current, inrush current, inrush time, Non-induction, power factor, time constant, No. of poles, No. of circuits, contact switching order, Average life, minimum life
Environmental (ambient) conditions	Temperature Humidity Pressure Atmosphere Acceleration Environment	Maximum, minimum, storage, during use, Maximum, continuous, intermittent, saturated, Atmosphere, vacuum, high pressure, Corrosive gas, chemicals, explosive gas, Vibration, impact, acceleration (gravity), Water, slurry, dirt, dust, sand dust
Mounting conditions (dimensions)	Dimensions and weight Mounting method Wiring method	Space or weight restrictions, Screw, bolt, other methods, Wiring method, terminal strength, connector

PRECAUTIONS FOR USE OF LIMIT SWITCHES

1. Cautions for actuator operation

1.1 When using a normally open (N.O.) contact, overtravel should be 1/3 to 2/3 of the rated value. (LS Series switches have a setting zone especially for this purpose.) Though mechanical life increases as overtravel (O.T.) is reduced, the actuator becomes more susceptible to external influence (contacts sometimes chatter due to vibration or impact, resulting in defective contact.) Also, set so that the actuator does not operate beyond the total travel (T.T.) or total travel position (T.T.P.) maximum values even in the event of an abnormal situation such as a large deflection of the actuating element.

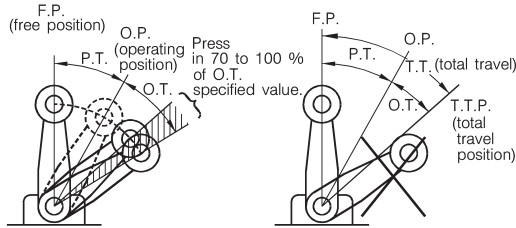

1.2 Prevent the actuator from exceeding the specified overtravel (O.T.) amount. If necessary, provide an external means such as a stopper to limit overtravel movement. If the limit switch is used with an actuator exceeding the specified O.T. value, not only will the life be shortened, but switch return defects and lever damage may also occur

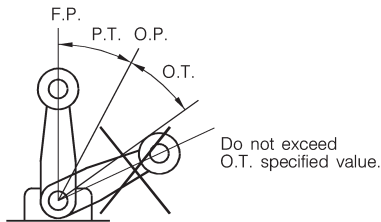

1.3 Set so that the actuator returns to the free position (F.P.) after operation. If the actuator does not return to the F.P., the internal switch may not turn OFF. For example, it may remain pressed in.

1.4 The operating position (O.P.), return position (R.P.), and operating force (O.F.) drift as the number of operations increases. For this reason, when initial design requirements necessitate accuracy, design the actuator to have sufficient margin, taking drift into consideration in advance.

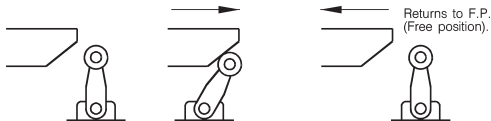

1.5 Select a smooth actuating element shape

When the actuating element or cam passes, the actuator is sometimes impacted, causing snapback. Also, sudden return of the actuator after the actuating element has passed sometimes damages the actuator or causes defective operation.

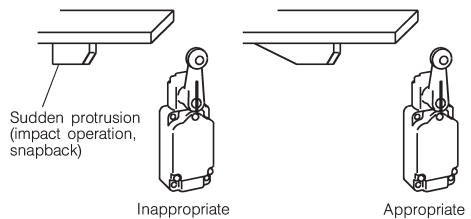
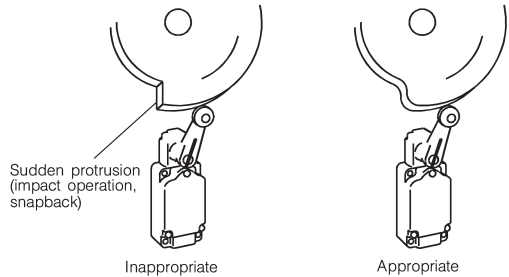
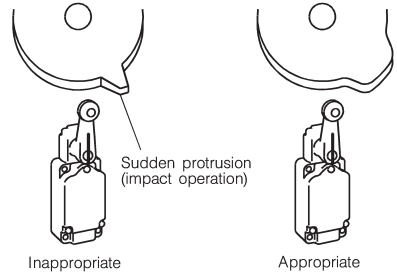
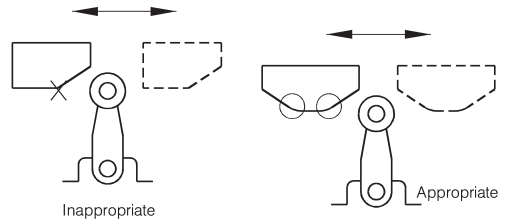

- 1.6** Prevent the actuating element from contacting the lever. If the actuating element contacts the lever, the operation shaft will be deformed, causing switch return defects.

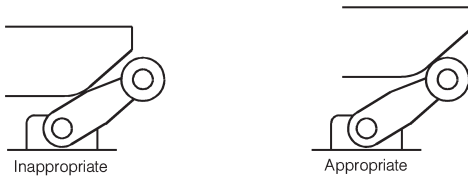

- 1.7** Design the actuating element or cam to be wider than the actuator (e.g., roller width) so that it acts on the entire surface of the actuator and moreover along its center point. If contact between the actuating element or cam and the actuator is incorrect, the roller may become worn on one side or the operating position may shift.

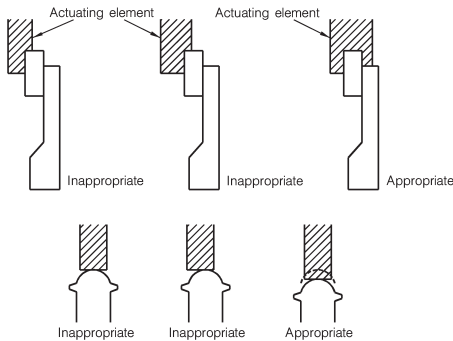

- 1.8** When two or more limit switches are used for different purposes, do not operate them with the same actuating element. If the position of the actuating element cannot be adjusted independently for each switch, differences in switch operating characteristics sometimes prevent setup of initial operation and prevent the specified operation from being carried out. If operation of two or more limit switches by a single actuating element is unavoidable, guard against looseness, and if necessary ensure adjustability by changing the mounting position of a switch.

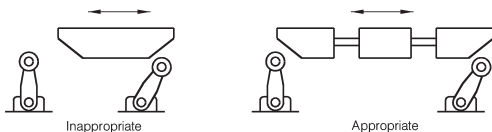

- 1.9** In situations where the actuator is operated at particularly fast speeds, use a cam or actuating element that has a long holding stroke. Otherwise, the signal from the limit switch may be a pulse signal, and relays may sometimes not operate.

- 1.10** Note that switch double action sometimes occurs not only due to fast-moving actuating elements but also due to the shape of the actuating element or cam.

- 1.11** When using long levers or long rod levers, put the lever facing downwards. This prevents the actuator from operating erroneously under its own weight. Either gently operate the actuator to check that it returns reliably, or make sure that the return force (R.F.) in the mounting direction is within specifications.

- 1.12** In position detection by limit switch, if the path is unstable due to, for example, the movement of the target object in a direction different from the operating direction of the switch, operate the limit switch via a striker to prevent limit switch malfunction or erroneous detection.

- 1.13** Do not modify the actuator. If modification is unavoidable, make sure that the actuator's performance has not changed.

- 1.14** When modifying the angle of a lever, bend the lever itself. If this is not possible, be sure to support the area between the actuator fulcrum and the lever while bending. Failure to do so might damage the switch.

- 1.15** To prevent malfunction caused by impact, reverse operation (with the switch set so that it returns to its original position at the end of the actuator stroke) is effective.

- 1.16** Try to avoid leaving limit switches in a constantly ON state for a long time. Doing so might cause changes in rubber or lubricant over time, leading to return defects.

2. Cautions for design of actuating elements

2.1 Angle of actuating element

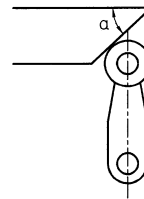

Generally, an actuating element angle α of 30-45° is suitable. Design the actuating element to match its travel speed. The smaller the actuating element angle α is, the smaller the force applied on the actuator. Note, however, that if an angle of 30° or less is set, repeatability error or stroke increases. Not only may this cause problems in actual use, but also a downward force may be exerted on the actuator shaft, causing the shaft to bend.

2.2 Speed and angle of the actuating element

The larger the actuating element angle α is, the smaller the max. allowable speed of the actuating element. When the actuating element does not ride over the actuator Speed of actuating element $V \leq 0.5\text{m/s}$ (low speed) The actuator can be installed vertically.

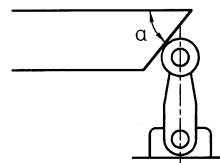

Dog angle α	Max. dog speed V
30°	0.4 m/s
45°	0.25m/s
60°	0.1 m/s
75°	0.07m/s
90°	0.05m/s

$0.5\text{m/s} < \text{Speed of actuating element } V \leq 2\text{m/s}$ (fast speed) Change the setting angle of the actuator according to angle α of the actuating element.

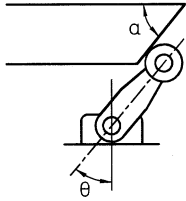

Angle of actuating element α	Setting angle θ	Max. speed of actuating element V
45°	45°	0.5m/s
40°	50°	0.6m/s
30 to 35°	55 to 60°	1.3m/s
15 to 25°	65 to 75°	2.0m/s

When the actuating element rides over the actuator Speed of actuating element $V \leq 0.5\text{m/s}$ (low speed) The actuator can be installed vertically.

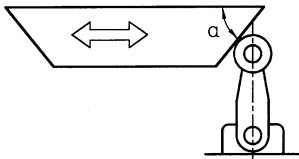

Dog angle α	Max. dog speed V
30°	0.4 m/s
45°	0.25m/s
60°	0.1 m/s
75°	0.07m/s
90°	0.05m/s

2.3 Surface roughness of actuating element

A surface roughness of 6.3S and hardness of about HV450 are suitable for the actuating element.

Note that the surface roughness and hardness of the actuating element greatly affect the life of the switch. Sliding is facilitated by applying a coating of lubricant to the sliding surfaces of the actuator and actuating element

3. Explanation of snap action

3.1 Principle of operation of snap-action mechanism

The snap-action mechanism is a spring mechanism comprising a tension spring and compression spring. The following shows the principle of operation of a JIS general purpose type (Z type) as a typical example.

Position State	Switch operation	Relationship between forces
Free position		
Operating position		
Total travel position		

F_0 : Combined force

F_1 : Reaction force by compression spring

F_2 : Pulling force by tension spring

- (1) In the free position (F.P.) where no external force is acting on the switch's actuator, the combined force is:

$$F_0 = F_1 + F_2$$

Moving contact c presses on fixed contact b with force F_0 .

- (2) When an external force acts on the switch's actuator, and the tension spring is deflected downward, the force changes to

$$F_1 = F_2$$

and force F_0 is equalized to 0. This position is the switch's operating position (O.P.). At this time, moving contact c and fixed contact b are in an open state.

- (3) If external force is further applied, force F_0 is exerted in the opposite direction to that in the free position,

$$F_0 = F_1 + F_2$$

and the moving contact moves to the opposite fixed contact and presses against it.

All basic switches use this principle of operation to switch contacts regardless of the speed at which the actuator is pushed.

3.2 Characteristics of force, stroke, and contact force

The figure below shows the relationship between the force applied to the switch's actuator and the actuator stroke (displacement) and the relationship between the contact force (force with which the contacts touch) and the actuator stroke.

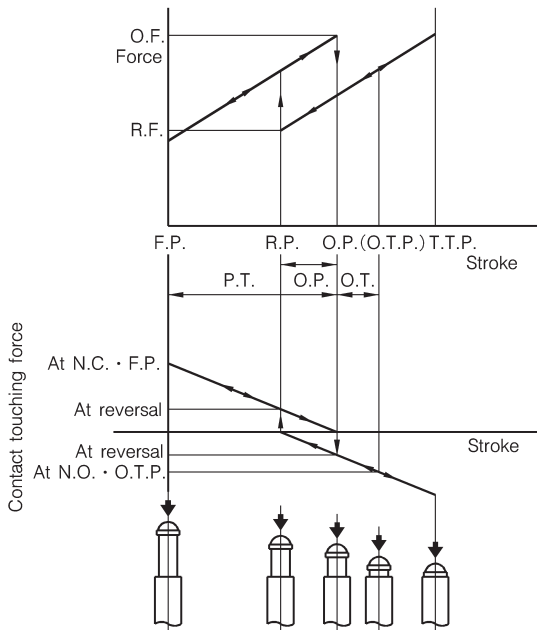

As basic switches are snap-action mechanisms, the relationship is always a hysteresis curve with a deviation between operation and the return stroke. The contact force decreases as the stroke increases from the free position (F.P.). At the operating position (O.P.), this force becomes 0, and the moving contact reverses to the normally open (N.O.) side to immediately generate contact force. Further, as the stroke increases, contact force increases so that stable contact is ensured. As can be seen from the above figure, the contact force becomes extremely small near O.P. and R.P., and a dead break (state in which the moving contact contacts neither the N.C. or the N.O. fixed contacts) may often occur. Owing to the above, it is important to pay attention to the following points when using a basic switch.

- To prevent unstable continuity caused by a dead break, do not stop the actuator near the operating position (O.P.) or the return position (R.P.), and provide sufficient stroke (O.T. and R.T.) within the specifications.
- Contact instability is more likely to occur when vibration or impact is large. When mounting the switch, adopt earthquake-proofing countermeasures as necessary, and provide sufficient stroke within the specifications.
- In the switching of low current loads where an increase or instability in the contact resistance will cause problems, provide an appropriate actuator operating speed and sufficient stroke (O.T. and R.T.) within the specifications.
- To shorten the time it takes to pass the dead break zone, use within the allowable speed range.

3.3 Characteristics of contact resistance and contact force

The resistance between contacts changes according to the contact force. The figure below shows that contact resistance stabilizes (decreases) as contact force increases. Alternately, contact resistance becomes unstable (increases) as contact force decreases.

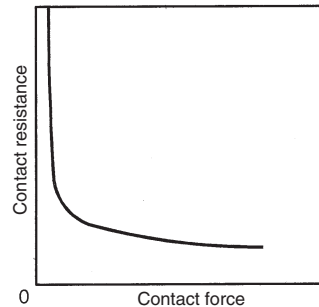

3.4 Contact switchover time

As limit switches use a snap-action mechanism, it is aid that the switchover time (reversal time) of contacts is fixed almost regardless of the operating speed of the actuator. However, the contact reversal time generally tends to increase at very slow operating speeds, which makes it more likely for an unstable contact state to occur. Accordingly, with limit switches, a minimum operating speed is specified to prevent contacts from fusing due to prolonged unstable time.

Contact switching time measurement circuit

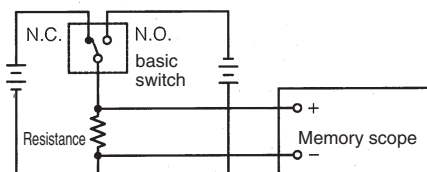

3.5 Vibration, impact

When limit switches are subjected to strong vibration or impact, malfunction caused by opening of the contacts or fluctuations in operating characteristics caused by wearing of parts sometimes occurs. If this happens, adopt the following countermeasures:

- Change the mounting direction of the switch.
- If overtravel (O.T.) is small, provide sufficient O.T. within 1/3 to 2/3 of the specified value to increase the contact force.
- Make the actuator as light as possible. Though this depends on the structure, generally better results can be obtained with a plunger type than with a roller lever type.

4. Cautions for switching loads

- Use limit switches after fully taking safety into consideration, for example, by providing an interlock function in the control circuit to prevent equipment damage and personnel accidents even in the event that the limit switch should malfunction.
- Switches must be used within the specified electrical rating. The current and voltage values at which switching is possible (called "switching capacity") are predetermined for switches. If the switch is used outside of this switching capacity, contacts may fuse, for example, accelerating switch degradation. For improved safety, select a switch with an electrical rating having sufficient margin. For example, when a switch rated at 15A is used at around 5A, drift in characteristics is normally 30% or less, and electrical life lengthens 10 times or more.
- Refer to the table below for which contact material should be selected for a particular load voltage and current. When referring to the figure, note that the usable operating area sometimes fluctuates according to the type of limit switch, contact force, operating conditions, ambient environmental conditions and type of load. Compound variations can result in these ranges overlapping. The overlap may also be extended further at its upper side, and may depend on the level of contact reliability required.

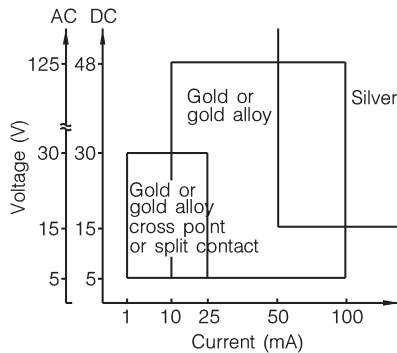

There is a difference between steady current and inrush current according to the type of load. Use at the allowable inrush current value or less.

Type of load	Inrush current (compared with steady current)
Resistance	1 x
Incandescent lamp	Approx. 10 to 15 x
Mercury lamp	3 x
Fluorescent lamp	Approx. 5 to 10 x
Motor	5 to 10 x
Solenoid	Approx. 10 to 20 x
Magnetic contactor	3 to 10 x
Capacitor	Approx. 20 to 40 x

- For low voltages of 15V or less, currents of 100mA or less, or load capacities of 0.2W or less, use a low current load switch to improve contact reliability.
- When using limit switches over a long time at low operating frequency, or when using on low current loads, contact defects sometimes occur with silver contacts because the sulfide film that forms on the surface of the contacts is not broken down. In these cases, use a low current load type of switch. Configure the circuit so that it will not be shorted if the limit switch malfunctions.

- Configure the circuit so that it will not be shorted if the limit switch malfunctions.
- Prevent different-pole loads from being connected to the contacts of a single limit switch.

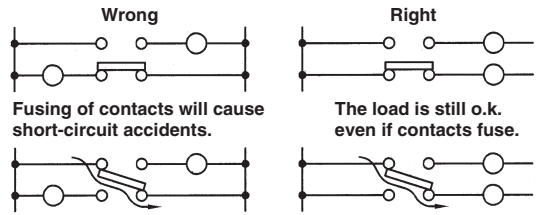

- Do not connect different types of power supply (AC, DC) to the contacts of a single limit switch.

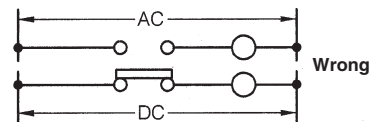

Crossing of DC and AC sometimes occurs if contacts fuse.

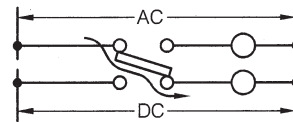

- Do not connect in such a way that voltage is applied between the contacts of a single limit switch. A permanent arc may be formed between the contacts, causing them to fuse.

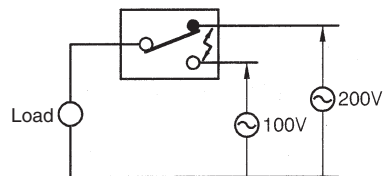

- In the case of loads (e.g. motors, solenoids, solenoid valves) where there is an inrush current 5 to 10 times the steady current, do not switch the load directly by the limit switch. Instead, insert a relay between the load and limit switch. If this is not possible, use at the allowable inrush current or less.
- Contact bounce occurs after the contacts have reversed by snap action. In particular, when controlling highly sensitive loads (e.g., electronic circuits), the length of this bounce time can cause malfunction of the load. Provide an appropriate absorption circuit (e.g., CR circuit).

- When the operating speed is extremely slow, snap action becomes unstable, and causes contact nonconformities or fusing. Alternately, if the operating speed is extremely fast, normal response is not possible, and the switch is damaged or the contact switching time no longer follows actuator operation. For this reason, use limit switches within the allowable operating speed ranges shown in the following table.

Series	Typical example	Allowable operating speed
LS	1LS1-J	1.7mm/s to 0.5m/s
SL1	SL1-A	0.02mm/s to 0.5m/s
14CE	14CE2	0.02mm/s to 0.5m/s

Generally, we recommend use within an operating speed of 1mm/s to 100mm/s. If use below the allowable operating speed is unavoidable, consider using a special product (a fuse-resistant operation type), available depending on the model.

- If the mechanical operating frequency is extremely high, excessive force is exerted on the actuator, which accelerates wear and damage of the operating head and internal moving parts. The temperature of the contacts also increases considerably, and the degree of contact, wear and transition increases, greatly shortening the life of the contacts. If this happens, use a non-contact type sensor such as a proximity sensor or photoelectric control.

Generally, we recommend using limit switches at a mechanical operating frequency of about 20 operations/minute.

5. Cautions for harsh environments

5.1 Ambient temperature and humidity

- Generally, standard limit switches can be used within a temperature range of -20 or -10°C to $+70$ or $+80^{\circ}\text{C}$. When using limit switches continuously outside of these ranges, use a heat- or cold-resistant

Heat-resistant type : Silicone rubber (Si) or fluoroplastic rubber (FPM) is used as the seal rubber. Heat-resistant lubricant is used. Heat-resistant phenol is the resin used for internal switches.

Cold-resistant type : Silicone rubber (Si) is used as the seal rubber. Cold-resistant lubricant is used.

- Do not use under temperature conditions that are outside the specifications.
- Do not expose to sudden heat changes.
- Generally, prolonged use of limit switches in humid conditions will deteriorate insulating resistance or result in the case dimensions changing. Consider detection by a cylindrical proximity switch instead.

5.2 Water, oil, dust, chips

- When using limit switches in locations splashed with water, oil, dirt, or chips, use a protective cover and mount the switch in a location where it is not directly splashed. To ensure that the limit switch is sealed, in addition to using a protective cover, use one of the following limit switches that have outstanding sealability:
SL1 Series
14CE Series
LS Series + PA1 sealed connector
- In locations subject to splashing by water or oil, or dusty locations, do not use the push plunger or roller plunger types, because their mechanical sections are not sealed.
- Dirt or dust accumulates on the plunger, sometimes causing return defects. If this happens, use a boot seal plunger or boot seal roller plunger type of switch.

- At locations where metal chips are present, do not use actuators with seal boot. Doing so might cause the seal boot to break off.
- If limit switches are splashed with water, rust may form on the actuator and hinder operation. Take countermeasures such as changing the mounting position, or consider using a corrosion-resistant limit switch.
- When using limit switches in locations splashed by water, oil, dirt and dust, or chips, water or oil sometimes enters the switch from the conduit due to capillary attraction. Also, dirt, dust and chips sometimes enter from the conduit. For this reason, adopt measures such as covering the switch until wiring is completed after mounting the switch.
- Also, when wiring, be sure to use a sealed connector compatible with the cable.
- Cable lead-out type sealed connector: PA1/PA1-□G Series
- Flexible tube lead out type sealed connector: PA3 Series



When using limit switches in locations where they are splashed by cutting fluid, use a double-seal type in which the internal switch itself is sealed. With this type of switch, it is difficult for cutting fluid to enter the internal switch even if it enters the limit switch. Example: Compact vertical type limit switch, LS Series, double seal type (□LS□-JS)

5.3 Gases

- In atmospheres containing flammable gases or flammable dust, use explosion-proof limit switches. Otherwise, on internal switches that use beryllium copper springs, springs may break or their characteristics may deteriorate.

*Use gold or gold alloy contacts in corrosive gas atmospheres such as hydrogen sulfide (H_2S) and sulfur dioxide (SO_2) gas.

5.4 Vibration, impact

When limit switches are subjected to strong vibrations or impact, malfunction caused by opening of the contacts or fluctuations in operating characteristics caused by wearing of parts sometimes occurs. If this happens, adopt the following countermeasures.

- Change the mounting direction of the switch.
- If overtravel (O.T.) is small, provide sufficient O.T. within 1/3 to 2/3 of the specified value to increase the contact force.
- Make the actuator as light as possible. Though it depends on the setup, generally better results can be obtained with a plunger type than with a roller lever type.

*Avoid subjecting the actuator to vibration or impact when in a pushed-in state. These conditions might cause local wear, or fluctuations in operating characteristics, resulting in defective switch operation.

*If the operating speed is relatively slow and there is vibration or impact, contact wear is accelerated and switch life is shortened because operation in an unstable state continues for a long time. In the case of light operation switches, the switch life is particularly shortened. If this happens, consider use of a proximity sensor or photoelectric control.

*Mount the switch in the direction that best withstands vibration.

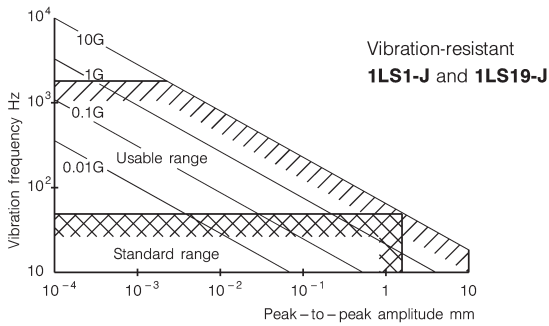

Impact resistance of preloaded basic switches

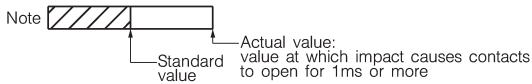
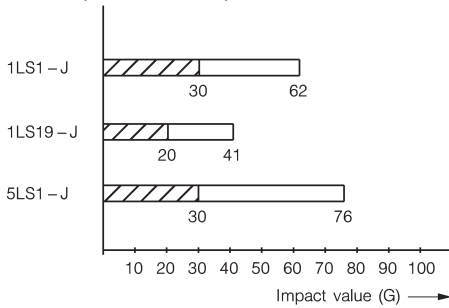

“Actual amount” does not assure product performance. Be sure to use within the standard amount of impact.

5.5 Outdoor use

- When using limit switches outdoors, use a limit switch whose mechanical section is sealed (JIS rainproof type, IEC protection class of IP63 or higher), and install a protective cover.

- Rubber materials in limit switches sometimes deteriorate due to ozone degradation. Use switches with weatherproof rubber (silicone rubber or chloroprene rubber) rather than the standard nitrile rubber.

Example: **LS Series compact vertical limit switch, corrosion-resistant type (1LS-J800)**

- Return defects sometimes occur on limit switch due to freezing. Use low-temperature limit switches.

Example: **LS Series compact vertical limit switch, low-temperature type (□LS□-JL)**

SL1 Series ultra compact limit switch, low-temperature type (SL1-□□□□L)

VCL Series waterproof center-neutral limit switch

- When using limit switch for long periods in locations near the coast, use corrosion-proof models.

Example: **LS Series compact vertical limit switch, corrosion-resistant type (1LS-J800)**

- When using limit switches for long periods outdoors, screw, plungers, and other iron parts sometimes become corroded. For such applications, use corrosion-proof limit switches.

Example: **LS Series compact vertical limit switch, corrosion-resistant type (1LS-J800)**

- Rain water sometimes enters limit switches from the strands of the lead wires due to capillary attraction. Wire the ends of lead wires to the inside of a terminal box.

- When using limit switches in locations where they are splashed by water, use corrosion-proof models. Aluminum alloy is sometimes corroded by moisture, which causes screws to rust.

Example: **LS Series compact vertical limit switch, corrosion-resistant type (1LS-J800)**

6. Mounting precautions

- Use the specified mounting screws and mounting holes.
- Never re-machine mounting holes or modify the switch body. Doing so might compromise switch performance.
- When mounting the lever on lever type limit switches, tighten once, and then tighten once again using stronger force if necessary.
- Avoid mounting limit switches in slotted holes. The limit switch sometimes moves out of position due to impact or vibration, preventing correct operation.
- When mounting lock washers, put the plain washer on first, followed by the spring lock washer.
- After adjustments and wiring, do not forget to tighten screws. In particular, on adjustable limit switches, for example with an adjustable roller lever, do not forget to secure the lever or arm after adjustment. Also, in the case of limit switches whose covers must be removed for wiring, do not forget to attach the covers and tighten screws.
- Tighten the operating head and covers at the specified tightening torque to obtain the optimum sealability of the limit switch. When tightening, gradually tighten opposite corners alternately.
- Do not use nuts to mount limit switches. Nuts may come loose due to impact or vibration, and are difficult to replace.
- Do not mount limit switches where they may malfunction as a result of normal movement of workers or machine elements.
- Mount limit switches in a location and with an orientation that facilitates maintenance adjustments and inspection.
- Do not coat sliding parts (e.g., actuator) with lubricating oil that may cause electrical accidents or return defects.
- Provide limit switches with wiring space as shown below.

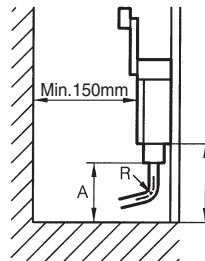

Determine the bending dimensions of cabletyre cable as follows:

A (sealed connector bottom dimension) = diameter x (5 to 10)

R (bend radius) = diameter x (3 to 5)

Diameter: O.D. of cabletyre cable

Install the limit switch so that movement of the cable near the lead-out port is prevented. If stress is repeatedly applied to the cable, the core leads might break or the cable might become damaged in low-temperature environments.

- Provide a water drain-off area on the wiring so that oil, water, or other fluids do not flow along the entire length of the wiring and directly enter the connector.

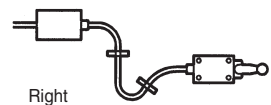
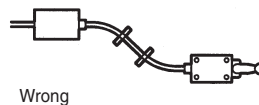

- Mount limit switches in the direction that is most resistant to water or oil droplets.

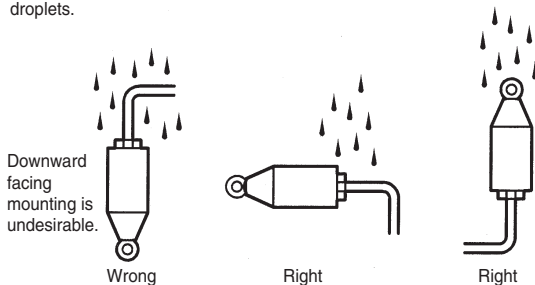

- When using explosion-proof switches in wet environments, use a protective cover to prevent water from directly splashing the sliding sections of the lever shaft or plunger. Consider use of a model having a plunger with boot.
- Mount a roller lever either at right angles to the switch body or along its center line to improve repeatability if the switch is replaced.

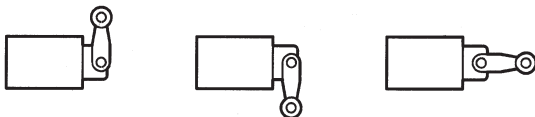

- Do not allow explosion-proof switches to be thrown around or dropped during transportation, or allow them to drop from workbenches, or use a hammer when mounting them. Doing so might change the operating characteristics of the switch or damage it.
- Store switches indoors in a well-ventilated location in a case that does not absorb moisture, and out of contact with corrosive gases.

7. Cautions when wiring limit switches

- Wire as shown in the figure, making sure that terminal lugs and wires do not overlap.



- Use 0.75 to 2.5mm² solid wire or twisted wire for wiring.
- Be sure to use round or Y-shaped crimp-type terminal lugs for wiring.
- When wiring to both sides of the N.O. and N.C. terminals, use insulated crimp-type terminal lugs.
- When the ground terminal is to be wired, use only one side of either of the N.O. or N.C. terminals. Avoid wiring to all five terminals as this may result in insufficient space inside the switch or insufficient insulation distance.

8. Cautions for limit switches with operation indicator lamp

- Wire limit switches with operation indicator lamp as shown below. These switches do not have + or -polarity.

Emergency lamp		
Circuit diagrams		
Note	<ul style="list-style-type: none"> • To ensure reliable lighting of the neon lamp, use at 75Vac or more. 	<ul style="list-style-type: none"> • Either 12 to 125Vac or Vdc can be used as the power for the indicator lamp (red LED). • The thermal current for the indicator lamp is max. 1.4mA for 100V power and max. 2.0mA for 125V power.
	E	EC

The indicator lamp lights when the spring on the cover over the lamp is connected to the circuit with the power supply and load, and when the switch contact is in an open (OFF) state.

- The current flowing to the indicator lamp is the leakage current of the load circuit. Normally, this leakage current is 1mA or less (1.5mA when using an E type at 200Vac). However, for safety's sake, use the limit switch after checking the OFF current of loads such as a PLC (programmable controller).
- When a terminal with insulation is used for wiring the switch, take care to prevent the spring on the cover over the indicator lamp from riding over the insulation, and make sure that the spring reliably contacts the terminal.
- Prevent the spring on a cover having an indicator lamp from being excessively bent when attaching the cover.
- The operation state indicator lamp is assembled so as to light when operation is at FREENO (in N.O. wiring). The indicator lamp can be made to light when operation is at PUSH by assembling the unit on the cover rear side in the opposite direction (in N.C. wiring).

9. HOW TO STORE LIMIT SWITCHES

When storing limit switches, pay attention to the following points to prevent product functions from deteriorating and to ensure safe and correct use.

9.1 Storage method

- When storing limit switches for long periods of time, store them in their original boxes.
- If special boxes are not available, put them in plastic bags or boxes to prevent direct contact with dirt and dust, and store them in such a way that they are not subjected to external impact.

9.2 Storage environment

- Store in the following conditions : Storage temperature: -30 to +85°C Storage humidity: 85% RH or less When storing for a long period of time, keep the storage location temperature within the 0 to 40°C range. Avoid storing in high-temperature, high-humidity locations.
- Store in a location out of the direct sunlight
- Avoid storing in locations where toxic gases (e.g., H₂S, SO₂, NO₂, NH₃, Cl₂) are generated. If limit switches must be stored in such environments, put them in (for example) a sealed plastic bag.

9.3 Storage period

The storage period depends on the storage method and environment. However, as a general guideline, switches can be stored for about one year. If you are considering storing switches for a longer period, place them in a plastic bag or the like to cut off contact with outside air. This will keep the limit switch in optimum condition.

9.4 Other

When limit switches have been stored for three to six months or longer, we recommend inspecting their exterior and checking operation and electrical continuity before use.

HANDLING SAFETY SWITCHES

Since improper handling of the safety switch may lead not only to impairment of switch functions, but also may create a serious safety hazard, handle the safety switch with the utmost care.

1. How to use

- The safety switch must be used within the reference values and limitations specified for each model.
- The design and construction of the safety system should be in accordance with the safety standards of the country where the equipment is installed, or in accordance with **EN 60204-1 (IEC 60204-1)**.
- Since machine or equipment safety cannot be achieved by the safety switch alone, the other elements, such as circuits interfacing with the machine or equipment, control circuits, and installation methods, also must satisfy local safety standards or **EN 60204-1 (IEC 60204-1)**. The total safety of machine or equipment in which the safety switch is used should be fully checked by the machine/equipment manufacturer and/or end user.

2. For use of the product

When using the safety switch, read and fully understand the user's manual that came with the switch, and handle the switch correctly in accordance with the information contained in the manual. Improper handling may cause the following hazards:

- Ignition
- Electric shock
- Operational failure of the switch
- Malfunction of the positive opening mechanism

3. Precautions for control circuit design (related to EN 60947-5-1)

- As a short-circuit protective device used with this safety switch, use a **Bussmann KTK-10 (10A)** fast-acting fuse or equivalent. If the fuse is blown by a short circuit, replace the safety switch.
- The safety switch must be used in a circuit with no more than 6,000V transient voltage.
- Be sure to operate the actuator up to the positive opening position to ensure positive opening of the contacts in case contact welding occurs.
- The N.C. contact of this switch is the contact for maximum safety, having a positive opening mechanism. Use the N.C. contact for safety circuit construction.